

FOUR ROLLER
FAIRLEAD

MODEL FR4-8

STANDARD FEATURES

- Designed with a S.W.L. of 70MT (154,324 Lbs or 686.5 kN) per O.C.I.M.F. Rev.3 Guidelines.
- Hardened Rollers for Longer Life
- Grease Lubricated Bronze Bearings
- Epoxy Primer Coating

OPTIONAL FEATURES

- Customized Design to Suit Your Application
- Seawater Lubricated Bearings for Underwater Use
- Bolt Down Mounting Base
- Stainless Steel Rollers
- Load Monitoring System
- Three Coat Marine Paint System
- Third Party Certification

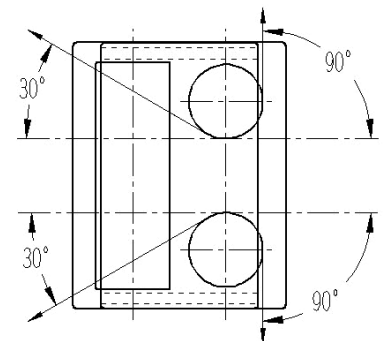
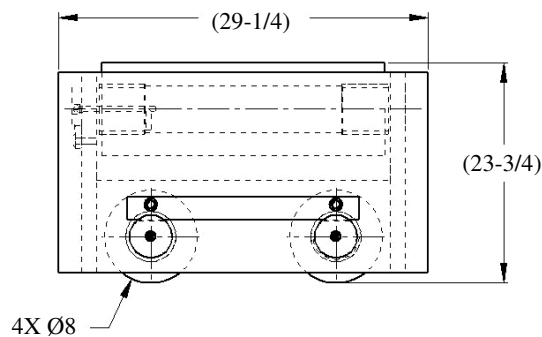

PLAN LOADING LIMITS

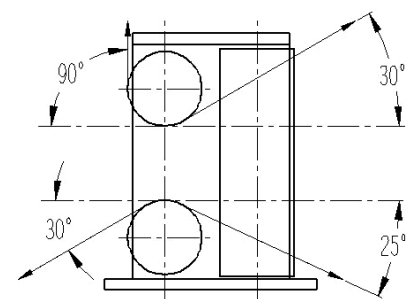
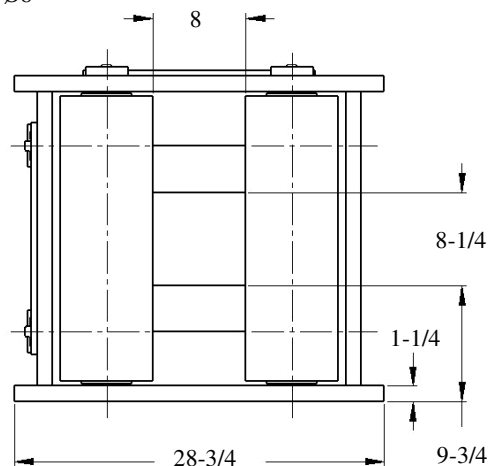
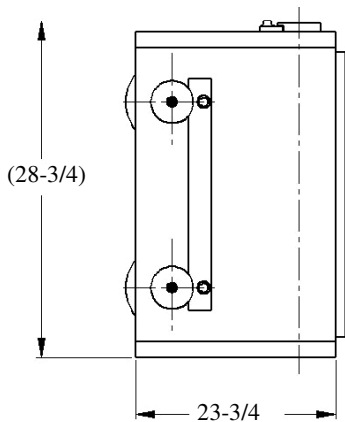

ELEVATION LOADING LIMITS

* DIMENSIONS SUBJECT TO CHANGE WITHOUT NOTICE*

WEIGHT: 1800 LBS

Rasmussen Equipment Company

415 S. Cloverdale St. Seattle, WA 98108
Tel: 206-762-3700

2220 Engineers Rd Belle Chasse, LA 70037
Tel: 504-392-0442

E-mail: info@RasmussenCo.com Web: www.RasmussenCo.com Toll Free: 800-227-7920